



**Yamato**

**Dataweigh  $\Omega$ <sup>TM</sup>**  
INNOVATION IN MOTION



# INNOVATION IN MOTION



# Dataweigh $\Omega$ <sup>TM</sup>

Yamato has been at the leading edge of weighing technology for almost 90 years. "Dataweigh Omega"<sup>TM</sup> series utilizes groundbreaking multihead weighing technology. **PATENT PENDING**

## ● IMPROVING PRODUCTIVITY

# 200wpm

 High speed

\*The above speed is for 14H double shift operation.

## ● EASY OPERATION

# Auto-tuning

 for optimum control

## ● FOOD SAFETY

Easy to clean

WATERPROOF

# IP67 | Best Sanitation Structure

## ● EASY MAINTENANCE

 Quick recovery and minimum downtime

## ● ENVIRONMENTAL RESPONSIBILITY

# 60% less

 Reduced power consumption



Optimum control of product flow



Individual collating chute



YDB bucket



Streamlined main body

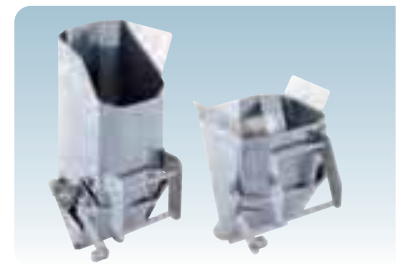

Polygon-shaped feed and weigh buckets



Unitization of actuator and feeder Easily removable and attachable buckets

“Dataweigh Omega”™ Series introduces innovative technology that is first in the world. This completely new multihead weigher provides customers with great benefits for productivity, operation, maintenance, food safety and environmental responsibility.



## Increased productivity

### Higher output and yield

- High-natural-frequency load cells minimize vibration impacts.
- Lattice digital filters reduce the influence of external vibrations and ensure higher weighing accuracy.
- Toggle-less gating mechanisms reduce mechanical impacts on load cells and suppress bucket gating noise.
- Individually adjustable collating chute angles maximize product discharge speed.
- Auto-tuning and Yamato AFC (automatic feeding control) ensure continuous optimum product flow.



## Ease of maintenance

- Improved design ensures easy replacement of actuators and feeders.
- No tools are needed to remove buckets and linear feeder pans.
- Enhanced protection of load cells can withstand up to 150 kg.

### Improved troubleshooting

- Simple screen diagnostics allow quick identification of problem areas.
- Part replacement time indicators prevent possible failures.



## Food safety

### Best sanitation structure

- Simplified fully stainless steel streamlined design.
- Seamless YDB bucket\* design leaves no spaces for dust or bacterial growth.

\*Yamato Diffusion Bonding (YDB) buckets are used in specific models.

### Easy to clean

- Compliant with IP67.
- Polygon-shaped bucket facilitates cleaning.



## Environmental responsibility

- Feedback control of feeders can achieve up to 60% power consumption reduction.\*
- Wider product windows reduce sealing errors and contribute to reducing packaging waste.

\*Compared to a conventional model





# AICC+

## Advanced Interactive Command Console Plus (RCU-1000)

This powerful new interactive command console provides easy access to all operational functions.

- 12.1-inch Color Touchscreen
- 300 Programs
- USB access port
- Built-in Printer
- 16 Languages
- Fingerprint authentication
- Ethernet access port
- Built-in Camera

## Easy Operation

- Auto-tuning, feeder amplitude and bucket gating set automatically, ensuring continuous optimal product flow
- Image-scanning with built-in cameras prevents program selection mistakes.
- Barcode readers use built-in cameras.
- Login management uses fingerprint authentication.
- Built-in operation manual



Automatic operation display



Built-in operation manual



Maintenance information display

## Network Remote Control and Data Acquisition

### Network connection capabilities (optional)

- PC remote control by LAN
- OPC & COM interface for data accumulation
- Feedback control between checkweigher and multihead weigher
- Troubleshooting and FAQs available in AICC+ support section of Yamato website
- Data acquisition

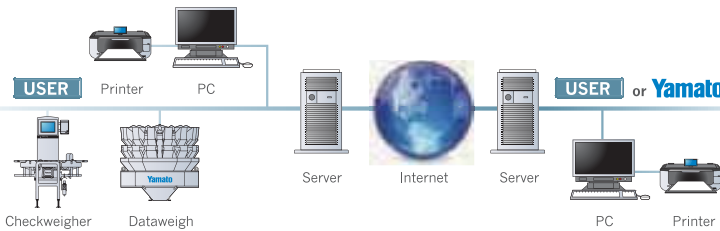

## Optional Features

- Counting Software
  - Priority head
  - Mixing Software
  - Multi-point Discharge
  - Product Inspection Camera\*
- \*CCD camera for real-time product monitoring on top cone and linear feeder pans

## Mixing Application

- Yamato's mix applications, which use a high-speed combination calculation system, can mix up to 8 different products on one weigher.
- Dataweigh Omega's mixing software handles a wide range of combination calculations. It optimizes among different product groups to achieve the best mix with high accuracy of individual components, for a total package weight.

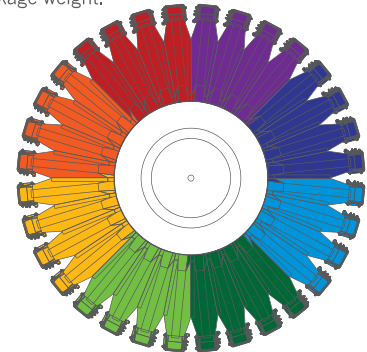

## "Dataweigh Omega"™ series models

	Model	Weigh Heads	Max. weighing range (g)	Volume per pack (ml)	Max. speed (wpm)	Max. discharge points	Dimensions	
							Width (mm)	Height (mm)
Dataweigh Omega series	O-0114S	14	500	1,000	210	1	800	950
	O-0116M	16	500	1,000	240	2	1,000	1,300
	O-0120S	20	500	1,000	210	2	1,100	1,150
	O-0124M	24	500	1,000	300	4	1,300	1,350
	O-0132S	32	500	1,000	420	4	1,800	1,650
	O-0132M	32	500	1,000	420	4	1,800	1,650
	O-0310S	10	1,000	3,000	100	1	1,200	1,400
	O-0312M	12	1,000	3,000	140	2	1,200	1,500
	O-0314S	14	1,000	3,000	200	1	1,200	1,250
	O-0316M	16	1,000	3,000	220	2	1,600	1,650
	O-0320S	20	1,000	3,000	200	2	1,600	1,750
	O-0320M	20	1,000	3,000	250	2	1,600	1,750
	O-0324M	24	1,000	3,000	300	4	1,800	1,950
	O-0610S	10	2,000	6,000	85	1	1,400	1,450
	O-0614S	14	2,000	6,000	170	1	1,400	1,500
	O-0616M	16	2,000	6,000	220	2	1,600	1,650
O-0620S	20	2,000	6,000	170	2	1,800	1,550	
O-0620M	20	2,000	6,000	220	2	1,800	1,950	
O-0624M	24	2,000	6,000	300	4	2,000	2,200	
O-1214S	14	3,000	12,000	130	1	1,600	1,900	
O-1220S	20	3,000	12,000	130	2	2,100	2,400	
O-1814S	14	5,000	18,000	100	1	1,800	2,000	

Above specifications and dimensions are subject to change without notice.

## Wide variety of weighing applications

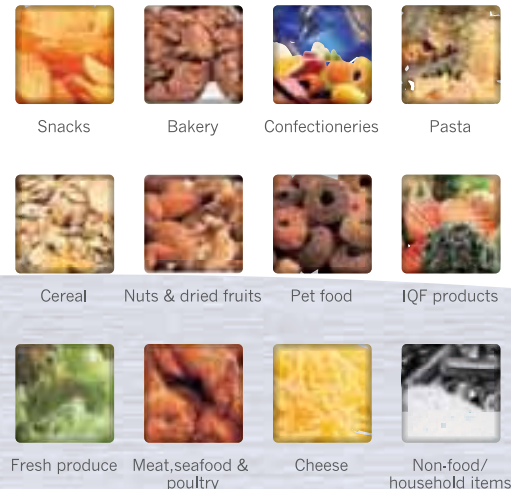

# Maximizing packaging performance

**Dataweigh  $\Omega$**   
Frontier/Divided Weigher



ADW-O-0132F

## Benefits of “Dataweigh Omega”™ Frontier

### Maximize production output

- Increase productivity through high-speed multipoint discharge
- Minimize production waste through wider product window
- Small footprint

### Increase packaging versatility

- VFFS (duplex, triplex, 4-tube, 6-tube) versatility
- Applicable to multi-point horizontal packaging machines and multi-lane tray lines

### Contribute to environmental protection

- Reduce packaging waste and weight
- Lower total cost of ownership

## Providing various discharge patterns

“Dataweigh Omega”™ Frontier series offers various types of discharge patterns

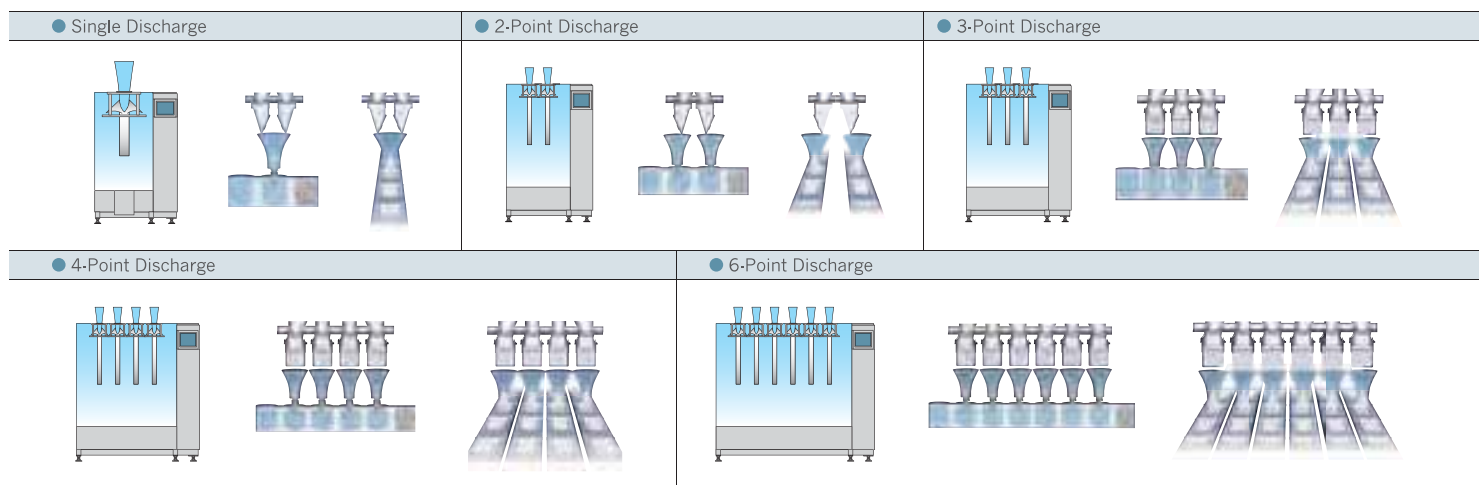

## Expanding packaging flexibility

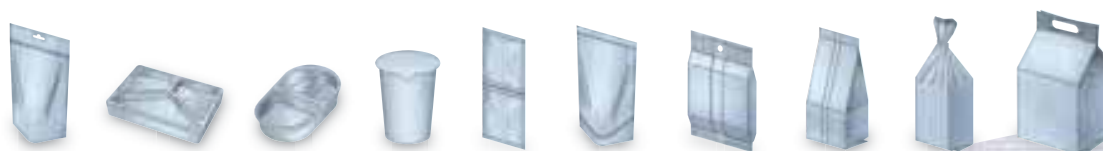

## Independent Discharge Channels

Changing from a standard single chute structure to a dual chute structure provides wider product discharge windows in high-speed operation.

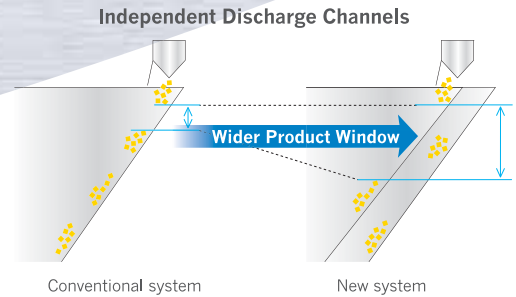

## Bottom Based Handling Device (BBHD)

The bottom based handling system temporarily retains the product that has dropped to the discharge chutes and on release ensures that no product is within the seal zone of the bag-maker. This reduces product waste and allows the use of thinner packaging film with ensuring sufficiently sealing time.

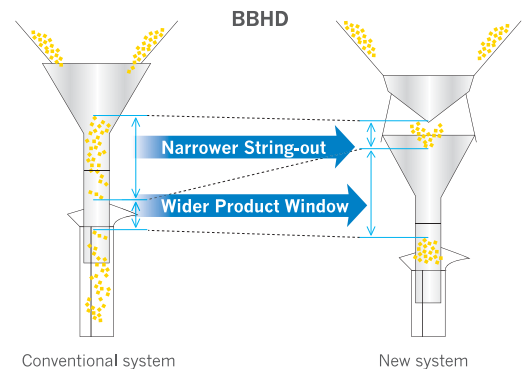

## Simultaneous combination

High accuracy and output are realized. Less loss means a fast return-on-investment.

## Multi-point Discharge

Yamato Multihead weighers with 1 to 6 discharge gates can fill tray lines, cup lines, HFFS, VFFS, rotary packing machines and other similar packaging applications. Multipoint discharge allows increased production.

## Divided Weigher

Divided weigher is comprised of completely independent discharge channels divided from one weigher, allowing weighing with higher speed and accuracy. Wider product windows with BBHD maximize multihead weigher performance in high-speed small bag lines.

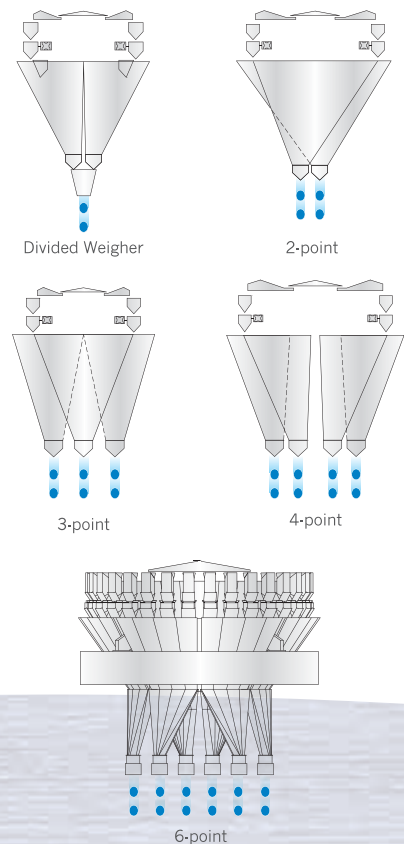

### ■ “Dataweigh Omega”™ Frontier series models

	Model	Weigh Heads	Max. weighing range (g)	Volume per pack (ml)	Max. speed (wpm)	Max. discharge points	Dimensions	
							Width (mm)	Height (mm)
Dataweigh Omega Frontier series	0-0114F	14	500	1,000	210	2	800	1,500
	0-0120F	20	500	1,000	315	3	1,100	1,500
	0-0128F	28	500	1,000	420	4	1,500	2,000
	0-0132F	32	500	1,000	630	6	1,800	2,000
	0-0314F	14	1,000	3,000	200	2	1,200	1,700
	0-0320F	20	1,000	3,000	300	3	1,600	1,900
	0-0614F	14	2,000	6,000	170	2	1,400	1,800

Above specifications and dimensions are subject to change without notice.



# About Yamato & Dataweigh™

Yamato Scale Co., Ltd. was founded in 1920 and has always been a leading manufacturer in the world of weighing machinery. In 1979, the first Dataweigh ADW-110 was developed. Since then, we have introduced many groundbreaking technologies, creating today's high-speed and highly accurate multihead weigher 'Dataweigh Series', which is used throughout the world. Our headquarters are in Akashi, Japan, and we have regional offices in the U.S.A., Germany, Netherlands, U.K., France, Russia, China and India, UAE, Mexico and Thailand. We also have a joint-venture in Korea and cover more than 70 countries with our representatives. Our highly experienced sales and service network provides customers around the world with a high level of expertise and service.

## ■ On-site-service



Installation



Application



Training



Repairs



Maintenance



Helpdesk & hotline

## ■ In-house-service

## Worldwide Sales & Service Network

Yamato is the only manufacturer of multihead weighers with wholly owned operations in America, Europe and Asia.

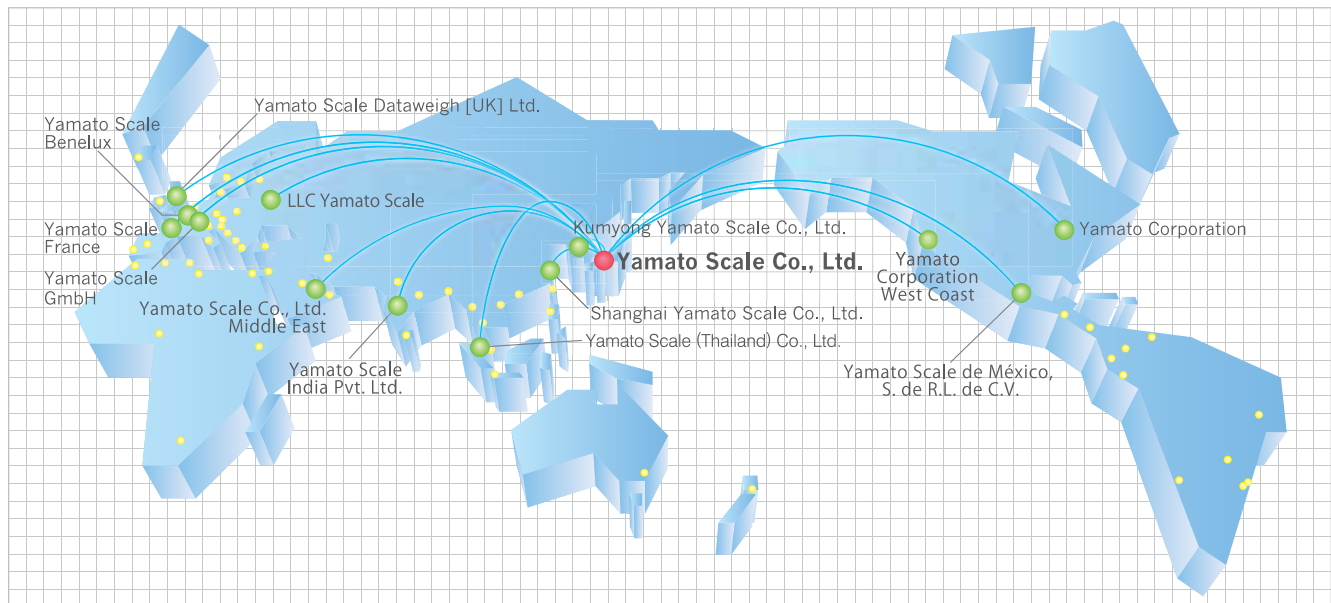

## Spare Parts & Service

Yamato Spare Parts and Service are subject to the same high demands of quality as the machines themselves.



Speed, weight and volume listed are standard. Other ranges are also available when required, please contact Yamato.

This machine is covered by number of patents worldwide. All illustrations and specifications are subject to change without notice.

## YAMATO SCALE CO., LTD.

5-22 Saenba-cho, Akashi, Japan 673-8688  
URL: <http://www.yamato-scale.co.jp/>

Telephone: +81(78)918-5566-5567-5568  
Telefax: +81(78)918-5552

### Yamato Corporation

6306 W. Eastwood Court  
Mequon, WI 53092 U.S.A.  
Telephone: +1(262)236-0000  
Telefax: +1(262)236-0036  
URL: <http://yamatoamericas.com/>  
E-mail: [info@yamatoamericas.com](mailto:info@yamatoamericas.com)

### Yamato Corporation-West Coast

Suite 1205 22600F Lambert Street  
Lake Forest, CA 92630  
Telephone: +1(949)238-4500  
URL: <http://www.YamatoAmericas.com>

### Yamato Scale de México, S. de R.L. de C.V.

Av. Dr. Gustavo Baz 191, Bodega F  
Col. El Mirador, CP. 54080, Tlalnebantla  
de Baz, Estado de México, México  
Telephone: +52(55)2628-6140  
URL: <http://yamatoamericas.com/>

### Yamato Scale Dataweigh [UK] Ltd.

3 Maple Park, Lowfields Avenue, Leeds,  
LS12 6HH, England  
Telephone: +44(0)113 322 1546  
Telefax: +44(0)113 350 2020  
URL: <http://www.yamatoscale.co.uk/>  
E-mail: [sales@yamatoscale.co.uk](mailto:sales@yamatoscale.co.uk)

### Yamato Scale GmbH

Hanns-Martin-Schleyer-Str. 13,  
D-47877 Willich, Germany  
Telephone: +49(0)2154 9159-0  
Telefax: +49(0)2154 40626  
URL: <http://www.yamatoscale.com/>  
E-mail: [sales@yamatoscale.com](mailto:sales@yamatoscale.com)

### Yamato Scale France

3 Avenue du Canada, Bâtiment Gamma,  
91940 LES ULIS, France  
Telephone: +33(0)1 64 53 24 40  
Telefax: +33(0)1 69 07 26 79  
URL: <http://www.yamato.fr/>  
E-mail: [Vente@yamato.fr](mailto:Vente@yamato.fr)

### Yamato Scale Benelux

Edisonstraat 4a, 5051 DS, Goirle,  
The Netherlands  
Telephone: +31(0)13 220 11 17  
Telefax: +31(0)13 460 90 81  
URL: <http://www.yamatoscale.nl/>  
<http://www.yamatoscale.be/>  
E-mail: [ysb@yamatoscale.com](mailto:ysb@yamatoscale.com)

### LLC Yamato Scale

Lublinskaya str. 151,  
109341 Moscow, Russia  
Telephone: +7(495)620 4870  
Telefax: +7(495)620 4877  
URL: <http://www.yamatoscale.ru/>  
E-mail: [salesru@yamatoscale.com](mailto:salesru@yamatoscale.com)

### Shanghai Yamato Scale Co., Ltd.

368, Qingda Road, Hejing Industrial Field, Pudong,  
Shanghai, ZIP code 201201, China  
Telephone: +86(21)58973377  
Telefax: +86(21)58973737  
URL: <http://www.yamatosh.com>

### Yamato Scale India Pvt. Ltd.

B-104, Okhla Industrial Area, Phase-I,  
New Delhi 110020, India  
Telephone: +91(11)4607 2882  
Telefax: +91(11)4607 2881

### Yamato Scale (Thailand) Co., Ltd.

1 Glas Haus Building, 12th Floor  
Soi Sukhumvit 25, Sukhumvit Rd.  
Klongtoey Nua, Wattana, Bangkok 10110  
Thailand  
Telephone: +66(0)2260-1057

### Yamato Scale Co., Ltd. Middle East (Branch)

Dubai Airport Freezone  
LIU-A07, P.O Box : 371911  
Telephone: +971(0)42952730  
Telefax: +971(0)42952729  
E-mail: [yamato@yme-01.ae](mailto:yamato@yme-01.ae)